

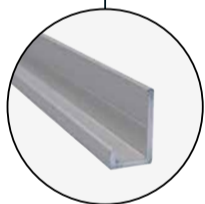

# Kitchen Board

INSTALLATION INSTRUCTION | MONTERINGSANVISNING



**Bottom profile** can be used for installing full wall in one.

**Bunnprofil** kan benyttes for montering av full vegg.

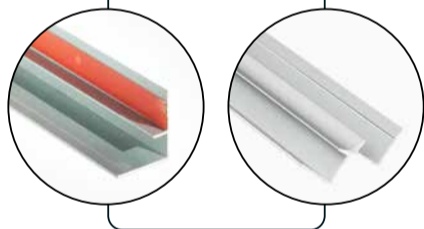

**Internal corner profile** is used to connect two panels in the corner.

**Innvendige hjørneprofiler** benyttes for å enkelt lage pene hjørneskjøter.



**L-shaped finishing profile** used for covering the cut surfaces.

**L-profil** benyttes for å skjule eventuelle kutteflater.



Use the Fibo accessories which are developed to ensure a perfect end result.  
Bruk tilpasset Fibo tilbehør som er utviklet for å sikre et perfekt og vanntett sluttresultat.



## Renew your kitchen in less than a day!

Use the Fibo Kitchen board as a decorative wall between the worktop and cabinets in your kitchen. Install easily with our Aqua-lock directly on the studs, or glue the panels on existing wall. Fibo Kitchen board is 100 % waterproof with a durable surface, easy to clean, and with 15 years product warranty.

Bruk Fibo Kitchen Board som en dekorativ vegg mellom benkeplaten og overskap på kjøkkenet. Monter enkelt med vår Aqua-Lock direkte på stendere, eller lim panelene på eksisterende vegg. Fibo Kitchen Board er 100% vanntett med en slitesterk overflate, lette å rengjøre, og med 15 års produktgaranti.



1. Stick it



2. Click it



3. Finish it

### TOOLS FOR INSTALLATION | MONTERINGSVERKTØY

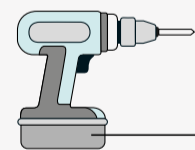

**Screwdriver with T10 bit and drill**  
Batteridrill med T10 bit og bor



**Pencil**  
Blyant

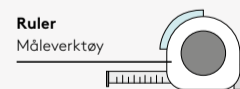

**Ruler**  
Måleverktøy

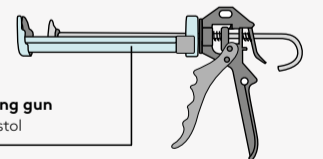

**Caulking gun**  
Fugepistol

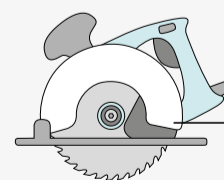

**Hand saw/Jigsaw/Circular saw**  
Håndsag/Stikksag/Sirkelsag

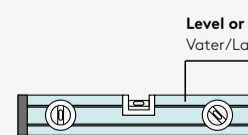

**Level or laser**  
Vater/Laser

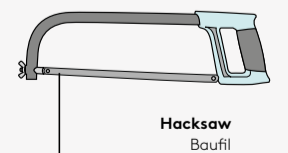

**Hacksaw**  
Bauffil

designbyfibo

**PREPARATIONS**  
FORBEREDELSE

**Fibo Kitchen Board with tile pattern**

Measure the total length of the wall and consider centering the tile pattern before starting the installation to achieve uniformed tile sizes. As an option, the Kitchen Board panels can also be glued to existing surfaces. The surface must be flat, irregularities removed/sanded.

**Fibo Kitchen Board med flismønster**

Mål den totale lengden på veggen og vurder å sentrere flismønsteret før du starter installasjonen for å oppnå uniformerte flisstørrelser. Fibo Kitchen Board kan også limes på eksisterende overflater. Sørg i såfall for at overflaten er flat, og at ujevnheter fjernes/slipes.

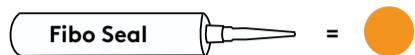

**CUTTING PANELS**  
KUTTING AV PANEL

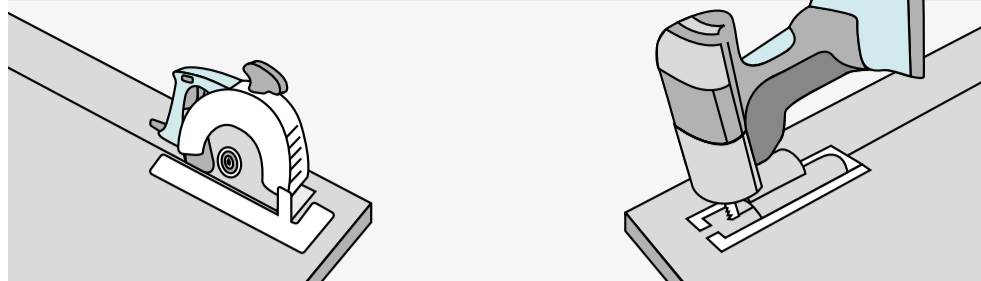

**Note: The saw teeth should face towards the laminate/decor to prevent chipping.**  
Merk: Sagtenner skal peke mot laminat/dekor for å unngå oppflising.

**A**

**INSTALLATION WITHOUT BOTTOM PROFILE**  
MONTERING UTEN BUNNPROFIL

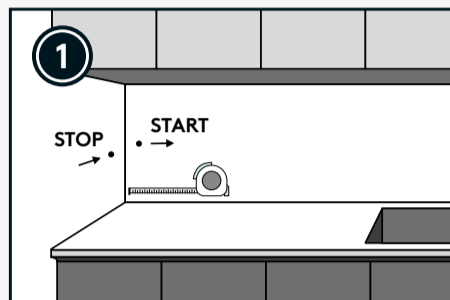

**1** The panels are installed from left to right. Adjust the height of the panels in relation to any wall cabinets. Panelene monteres fra venstre mot høyre. Justér høyde på panelene i forhold til eventuelle overskåp.

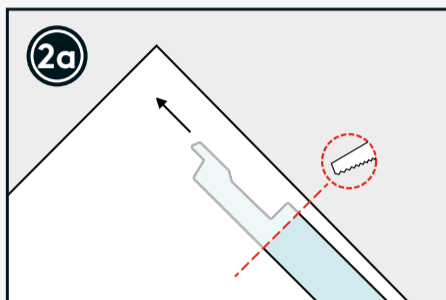

**2a** Trim the locking part from the first panel, ensuring to leave 2-3 mm space for the L-profile if this is chosen. Kutt av klikklåsen på første panel. Husk å beregne 2-3mm for eventuell L-profil dersom dette er valgt.

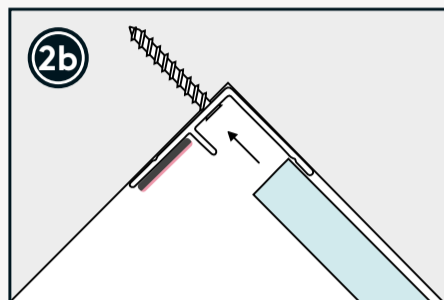

**2b** If using the hidden corner profile, this must be screwed to the backwall. Install first panel. Ved bruk av skjult innvendig hjørneprofil må denne festes med skruer til veggen før første panel monteres.

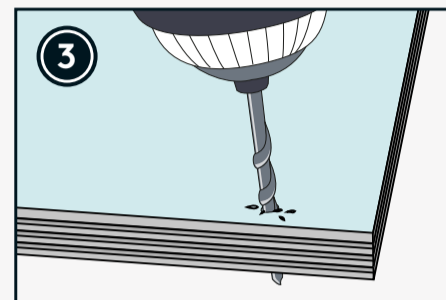

**3** Panel edges to be covered by L-profiles should be pre-drilled for the best result. Endekant av panel som senere vil bli dekket av en L-profil, bør forbores for best mulig resultat.

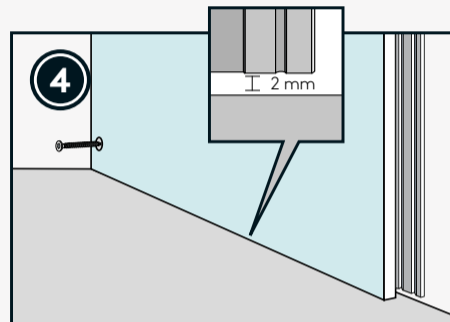

**4** Keep 2-3 mm distance from worktop to bottom of panel. This gap will be filled with Fibo Seal. Behold 2-3 mm avstand fra benk til bunn av panel. Denne glipen fuges til slutt.

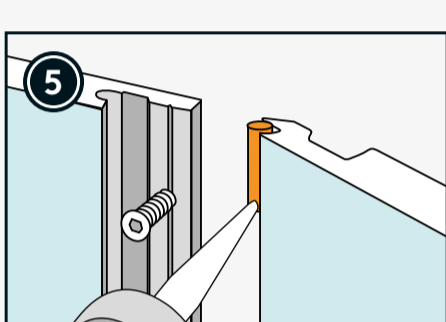

**5** Fasten first panel with Fibo Screws. Apply sealant on the left side of next panel before connecting for a waterproof result. Fest første panel med Fibo Screws. Påfør fugemasse på venstre side av neste panel og klikk sammen for å få et vannrett resultat.

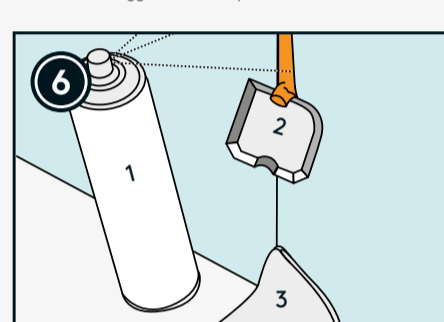

**6** Excess sealant is easily removed by using Fibo Clean and Fibo Sealing Tools. Fibo Wipes can also be used, but soap residue from Fibo Wipes should be removed with paper and water to avoid stains. Overskytende fugemasse fjernes enkelt med Fibo Clean og fugekluss. Fibo Wipes kan også benyttes, men såperester fra Fibo Wipes bør i såfall fjernes med papir og vann for å unngå skjolder.

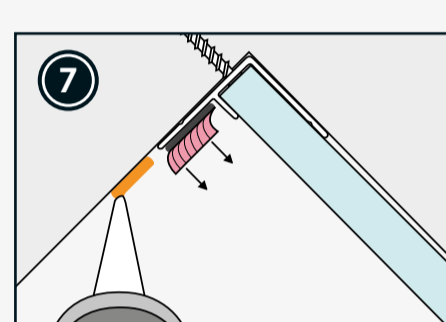

**7** Place a bead of Fibo Seal on the left hand side of the corner profile. Remove protective tape cover on the corner profile before clicking in the last panel. Påfør Fibo Seal fugemasse til venstre for hjørneprofilen. Fjern beskyttelsesfilm på tape før siste panel monteres.

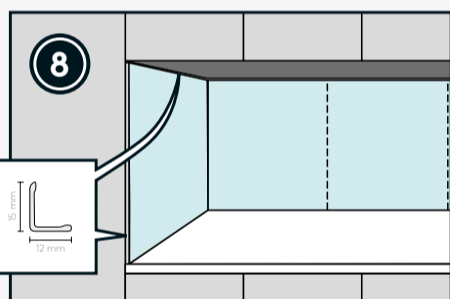

**8** L-Profiles can be used on all cut surfaces to hide screws. L-Profilen kan benyttes på alle kuttflater for å skjule skruer.

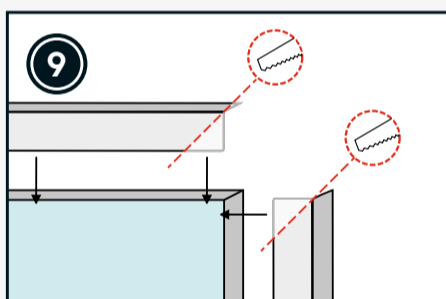

**9** To cover the cut surfaces use an L-profile, cut to length and mitre the corner 45°. For å dekke kuttflatene på panelet, tilpass L-profilens lengde og lag en sammenføyning på 45°.

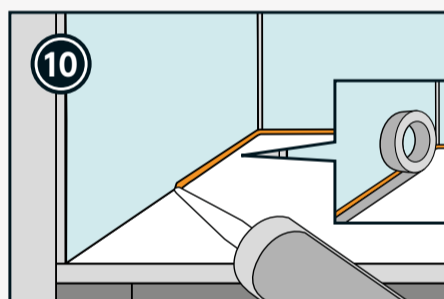

**10** Apply Fibo Seal in the gap between the panels and worktop, and in corners. Masking tape on worktop can be used. Use Fibo Clean and Fibo Sealing Tools for a nice end result. Overgangen mellom panel og benkeplate fuges med Fibo Seal. Det samme gjøres i innvendig hjørne. Maskeringstape på benk kan benyttes. Bruk Fibo Clean og fugekluss for et pent sluttresultat.

**B**

**INSTALLATION WITH BOTTOM PROFILE**  
MONTERING MED BUNNPROFIL

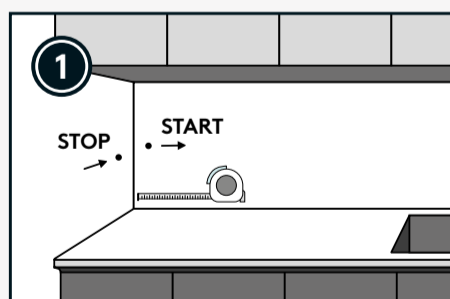

**1** Measure area and adjust panels according to center position and cabinet height if needed. Mål areal og tilpass plater mhp midtstilling og høyde hvis behov.

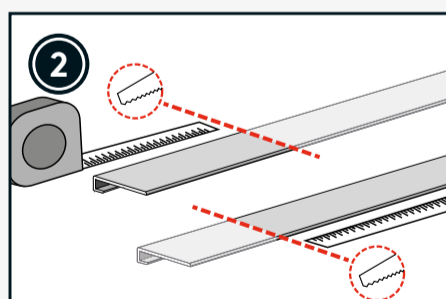

**2** Adjust length of bottom profiles. Place a string of Fibo Seal under the bottom list for a waterproof system. Tilpass lengde på bunnlist. Legg en fugestreng under bunnlist for å vannrett sjikt mot benk.

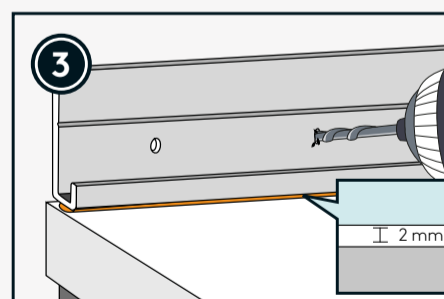

**3** Fasten the bottom list to the back wall about 2 mm above the bench to make room for the sealant. Fest bunnlisten til bakveggen ca 2 mm over benk for å gi plass til fugestrengen.

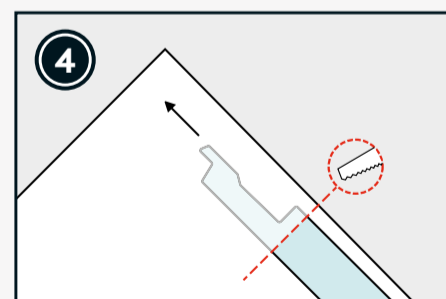

**4** Align the Kitchen Boards and assemble them into a continuous length. Apply Fibo Seal in the joints as shown in images 5 and 6 above. Tilpass og klikk sammen dine Kitchen Board panel til en hel lengde. Benytt Fibo Seal i skjøter iht bilde 5 og 6 over.

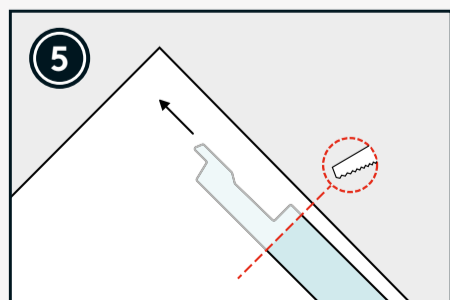

**5** Adjust the Kitchen Boards and click together to an entire length. Use Fibo Seal in joints according to image 5 and 6 above. Kitchenboard plater tilpasses og klikkes sammen til en hel lengde. Benytt Fibo Seal iht bilde 5 og 6 over.

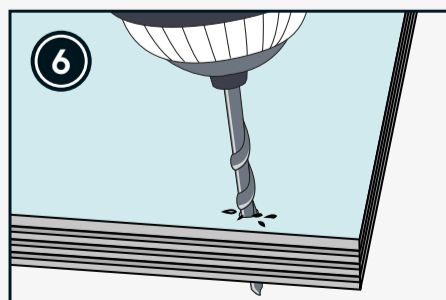

**6** Pre-drill the outer panels before putting them in place. Forboring i ytterplatene utføres før platene settes sammen.

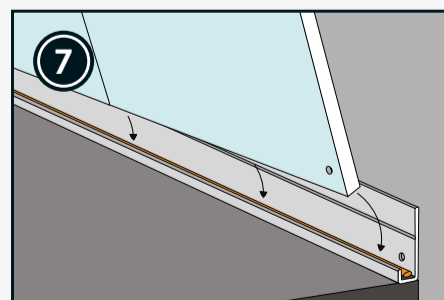

**7** Apply sealant to the base of the bottom profile. Lift the panels collectively and place in the bottom profile. Remove excess sealant. Påfør fugemasse i bunnen av bunnlist. Platene løftes samlet opp og settes i bunnlisten. Overflødig fugemasse fjernes.